

FL1005  
47-18

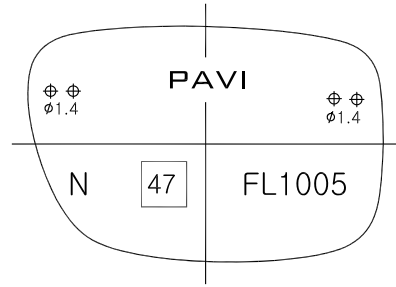

FL1005  
49-18

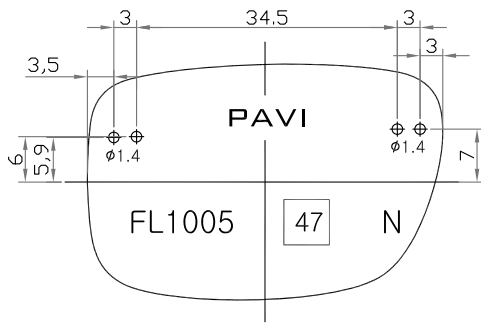
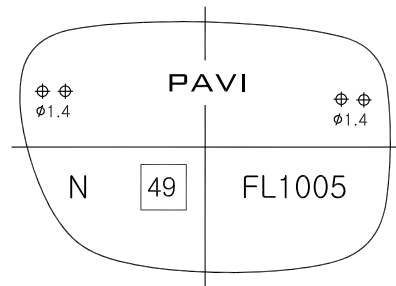
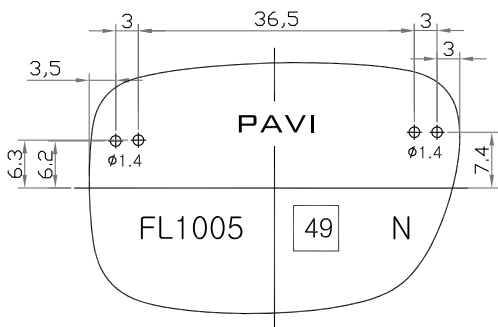

FL1005  
51-18

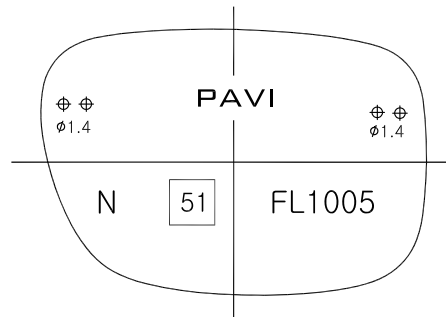
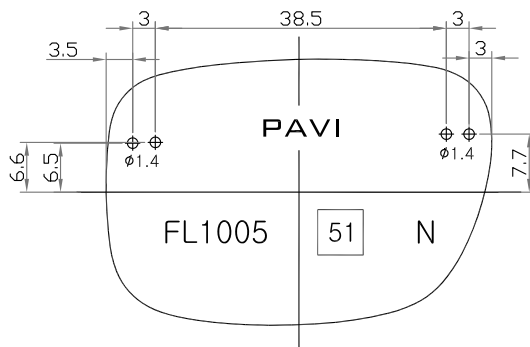

FL1010  
53-18

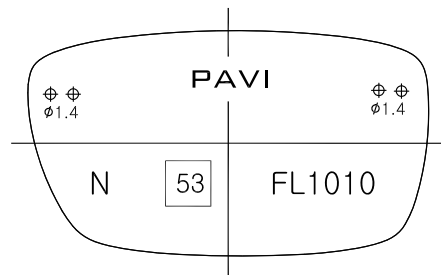
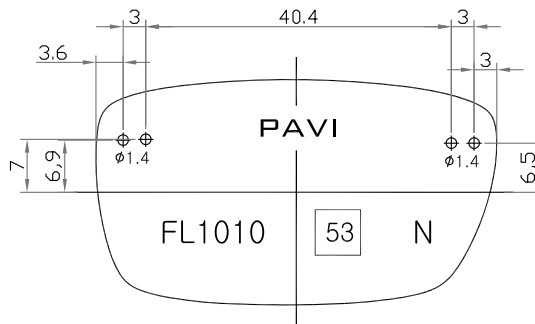

# FL1015

48-18

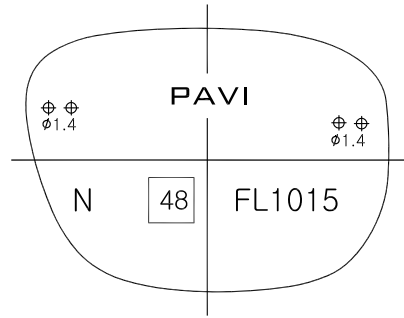
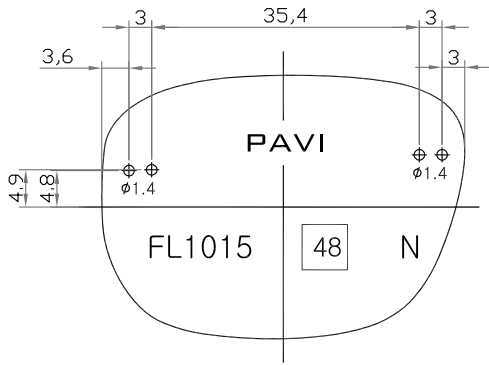

# FL1015

52-18

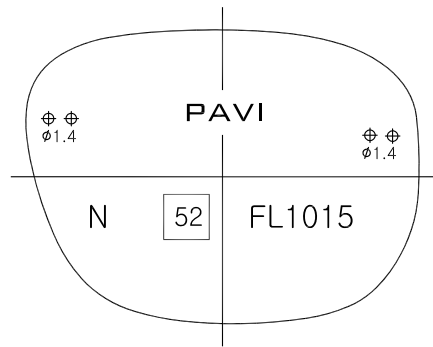
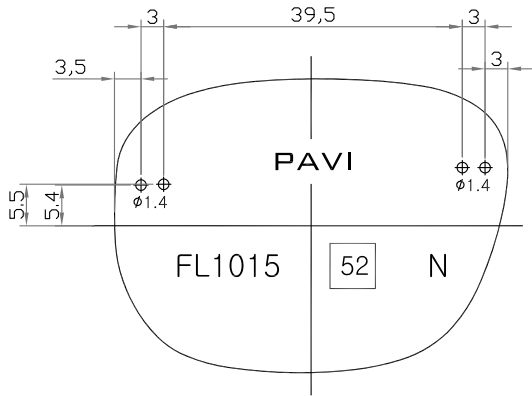

# FL1020

48-18

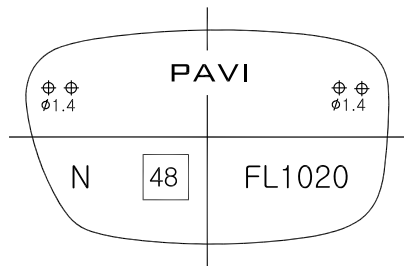
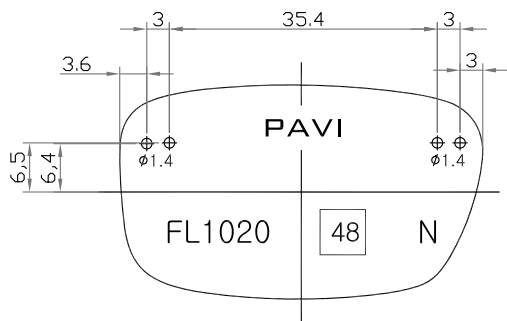

# FL1025

51-18

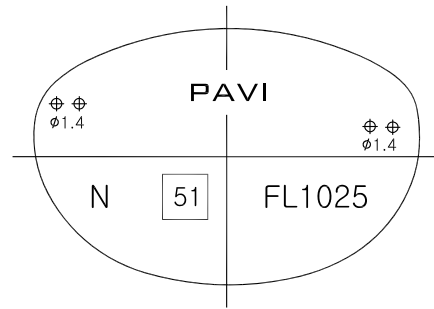
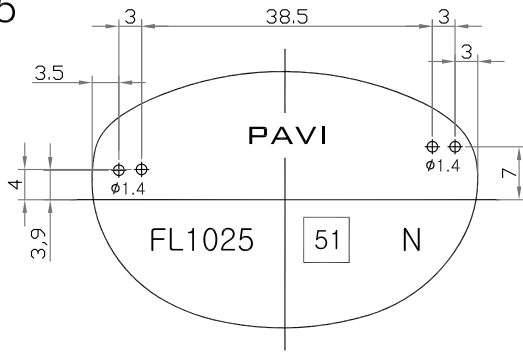

# FL1030

50 - 18

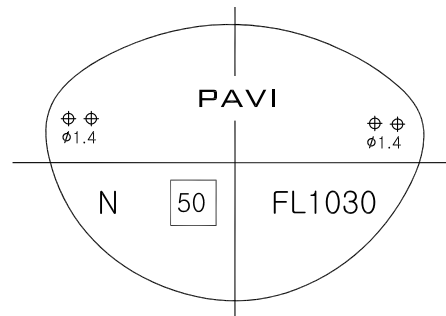
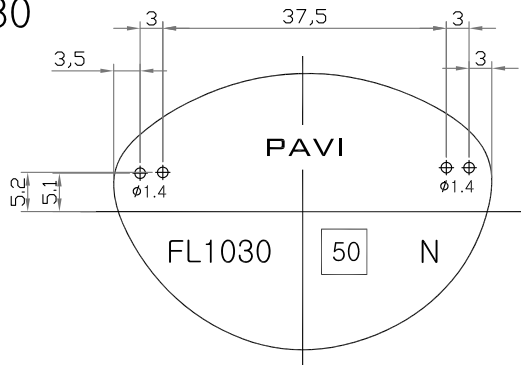

# FL1035

52-18

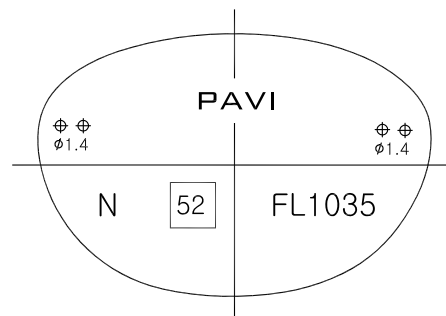
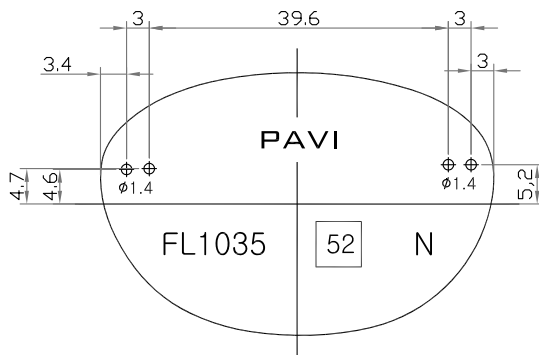

# FL1040

50-18

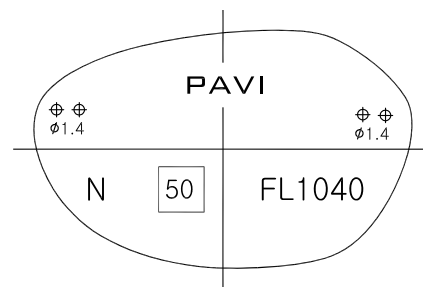
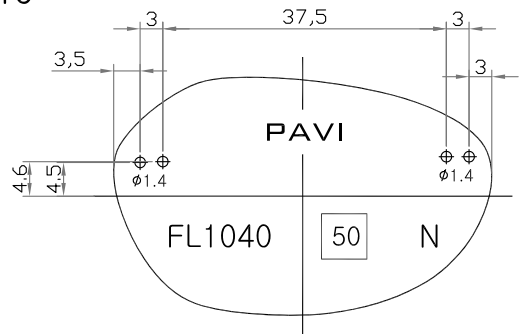

FL1045  
48 □ 18

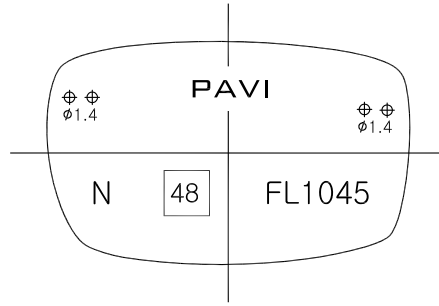
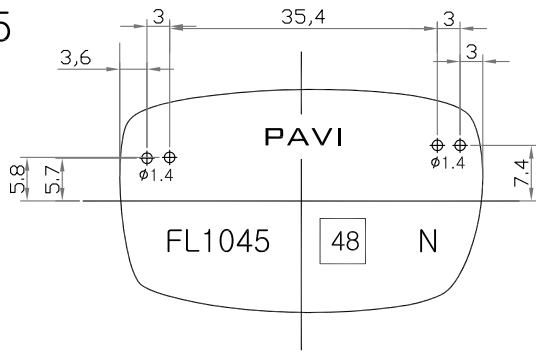

FL1045  
50 □ 18

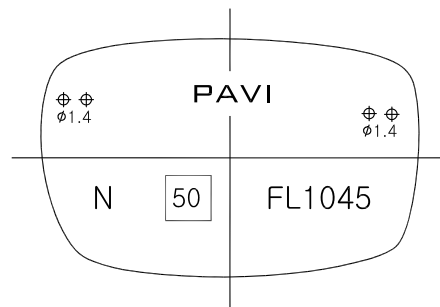
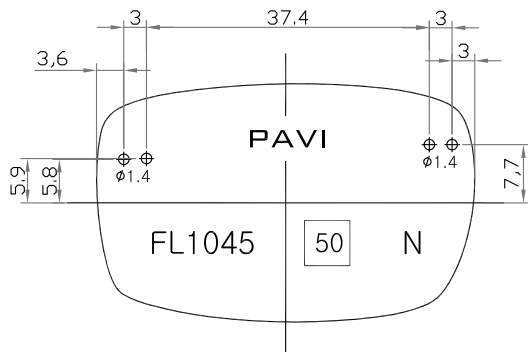

FL1045  
52 □ 18

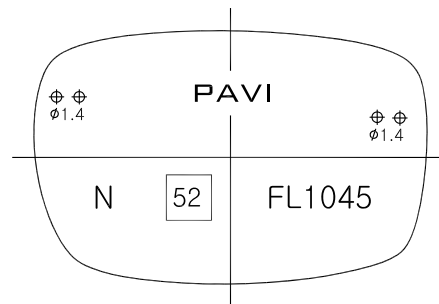
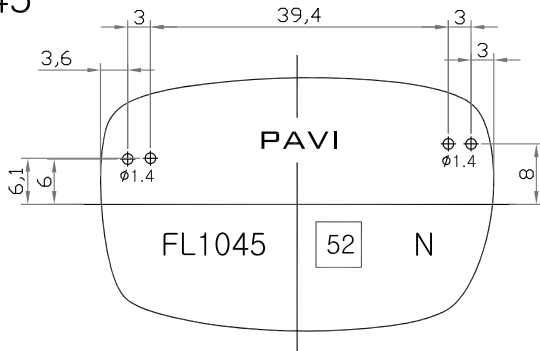

FL1050  
53 □ 18

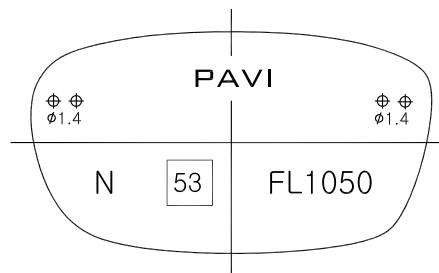
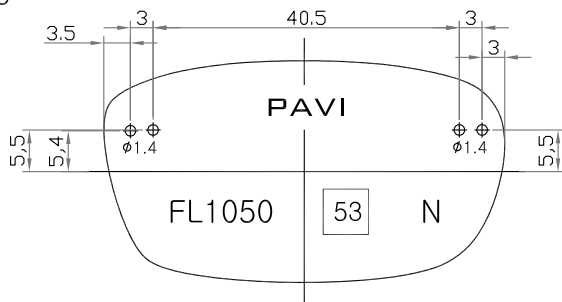

# FL1055

48-18

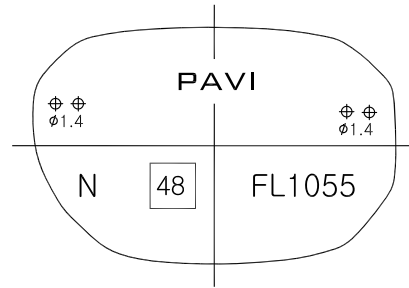
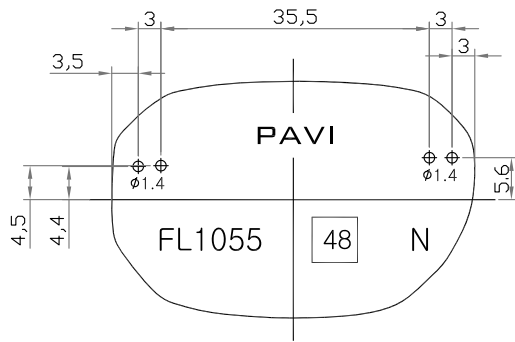

# FL1060

48 □ 18

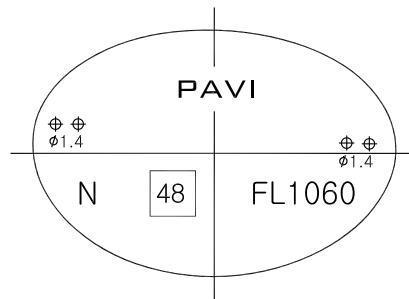
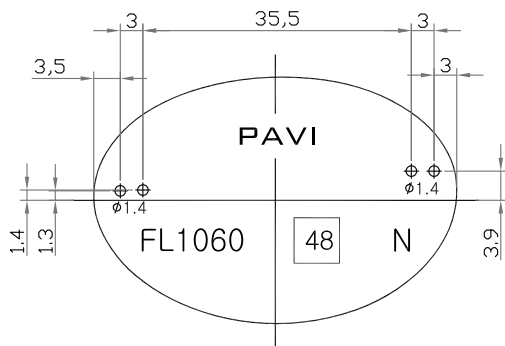

# FL1065

49 □ 18

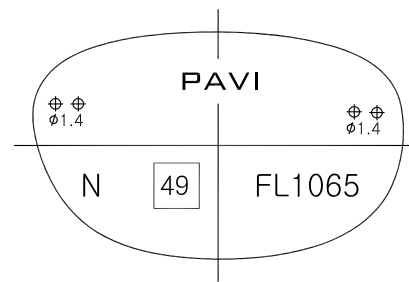
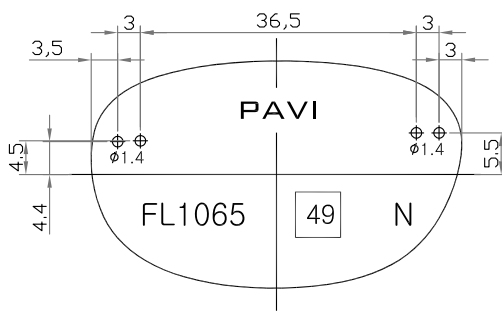

FL1070  
48 □ 18

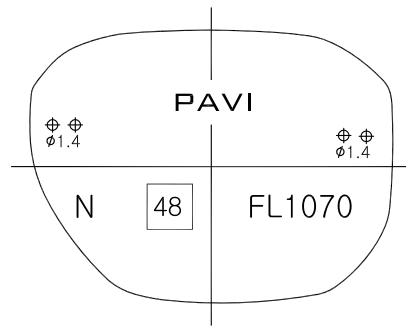
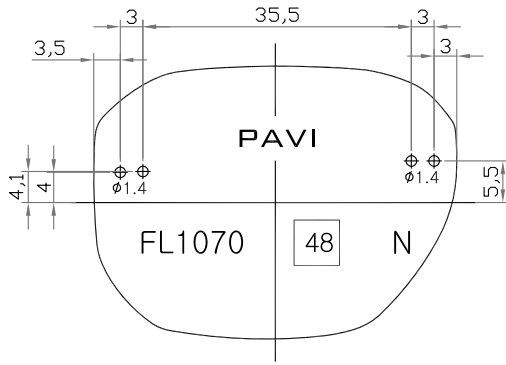

FL1070  
50 □ 18

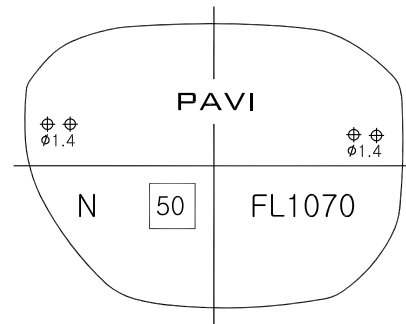
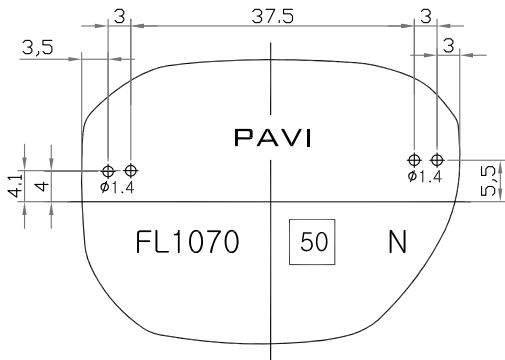

FL1075  
48 □ 18

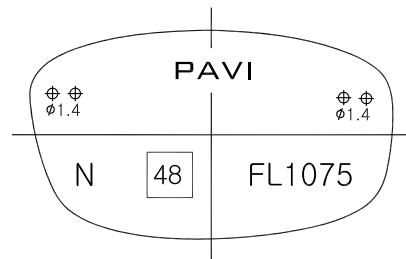
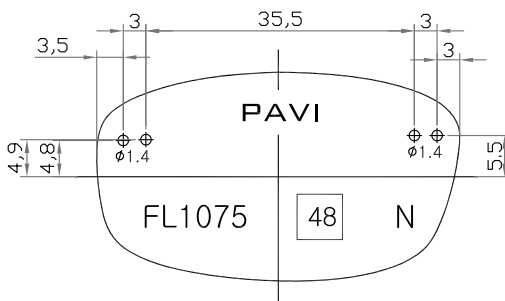

FL1080  
47 □ 18

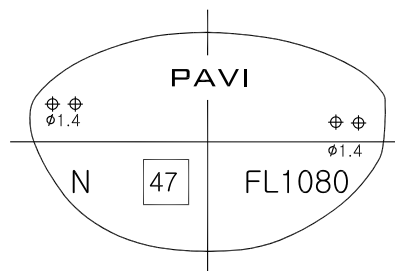
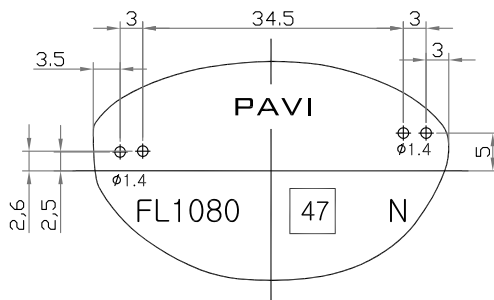

FL1085  
50-18

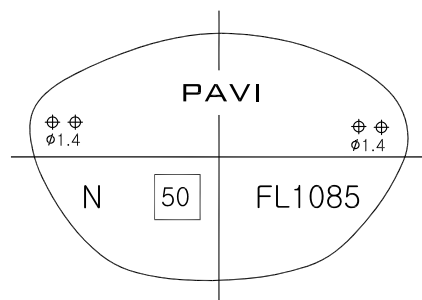
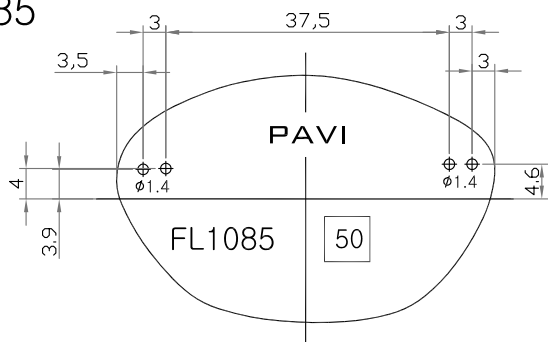

FL1090  
50 □ 18

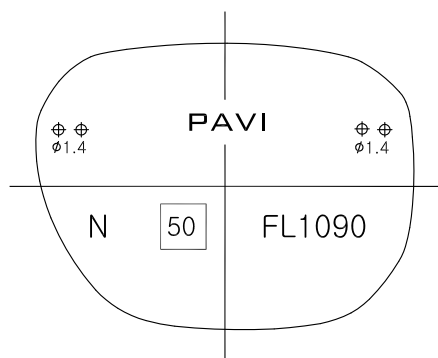
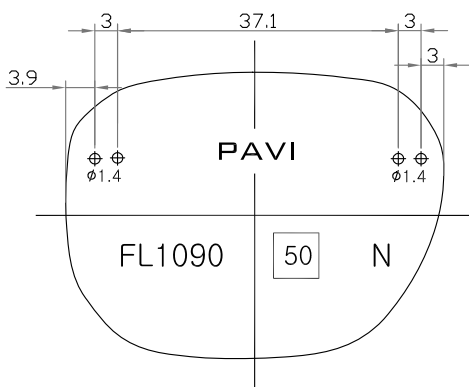

FL1090  
52 □ 18

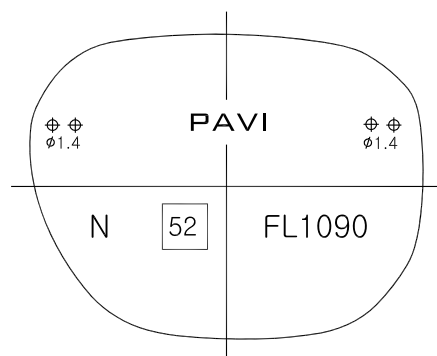
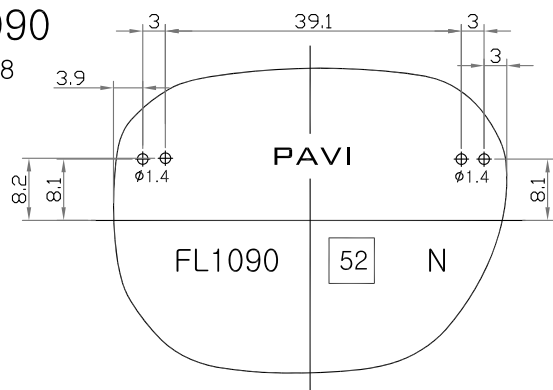

FL1095  
50 □ 18

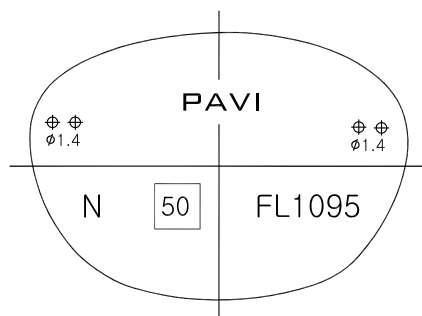
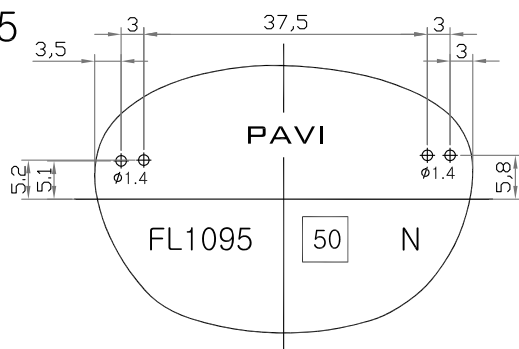

FL1100  
47 □ 18

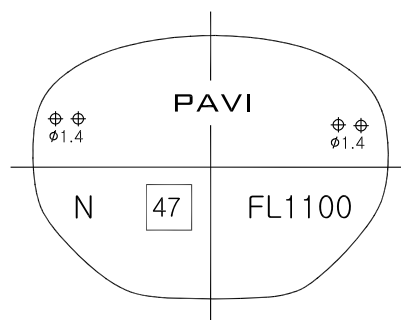
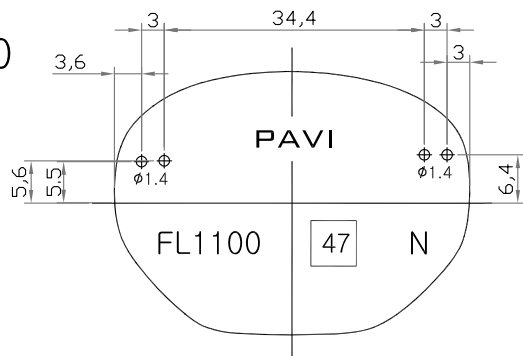

FL1105  
50 □ 18

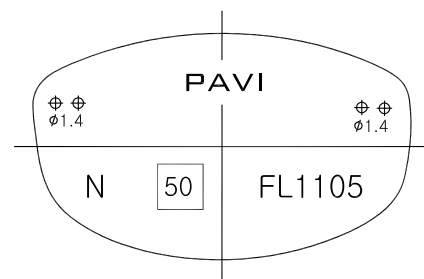
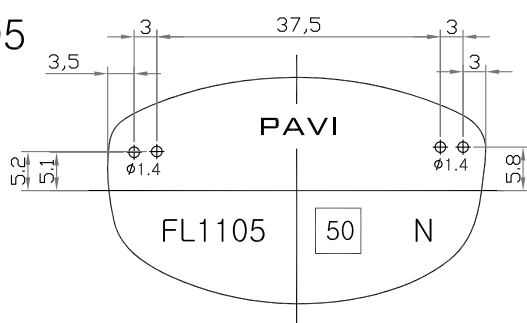

FL1110  
49 □ 18

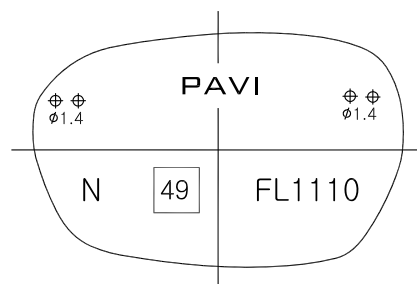
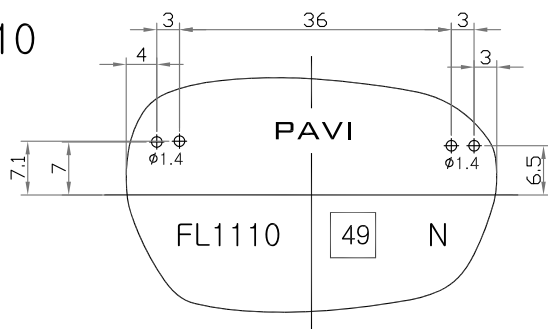

FL1115  
55 □ 18

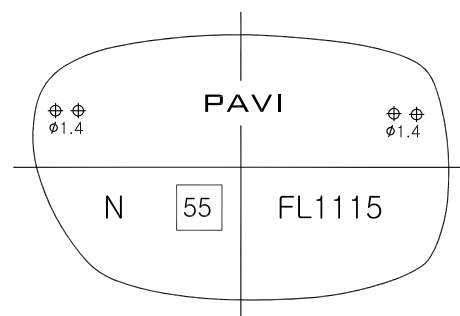
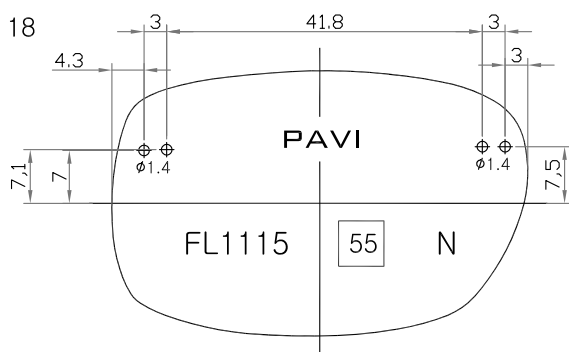

FL1120  
47□18

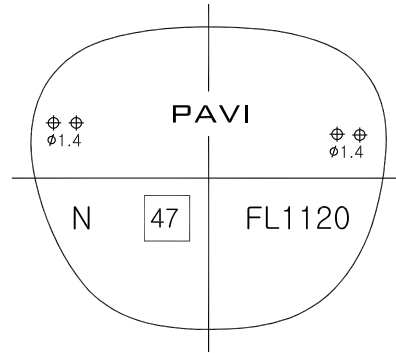
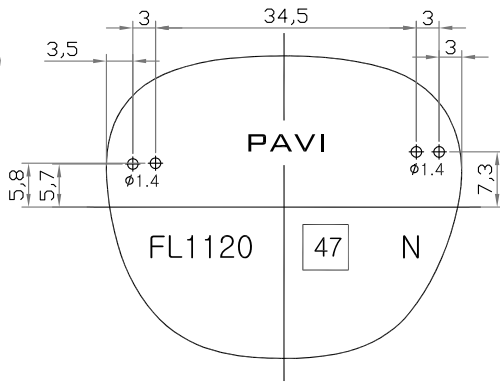

FL1125  
53□18

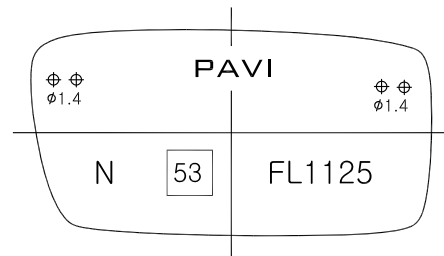
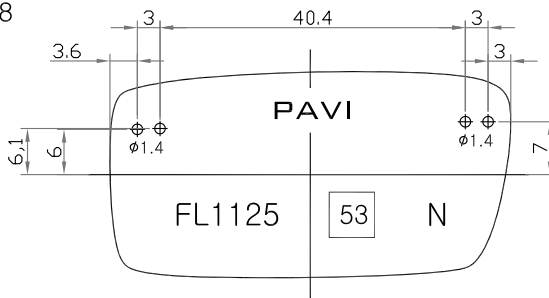

FL1130  
54□18

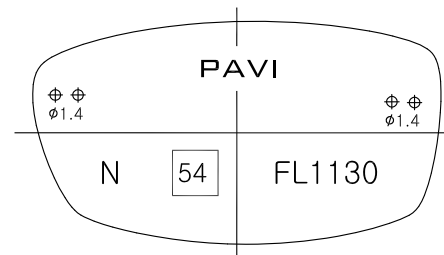
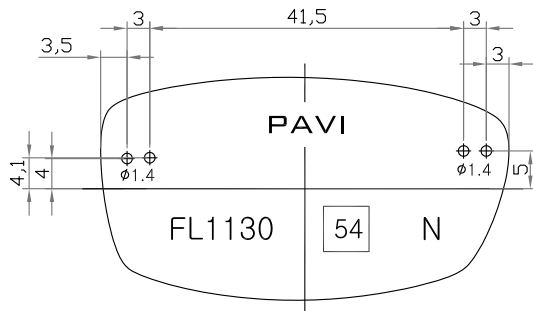

FL1135  
55□18

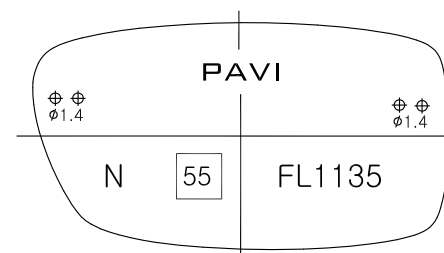
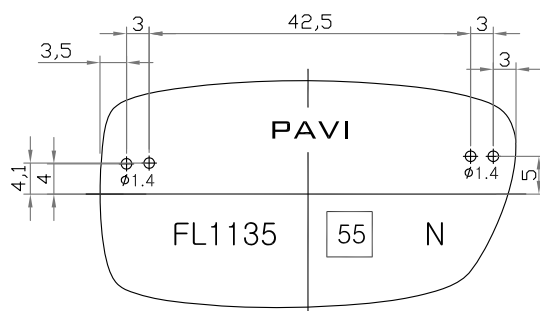

# FL1140

54 □ 18

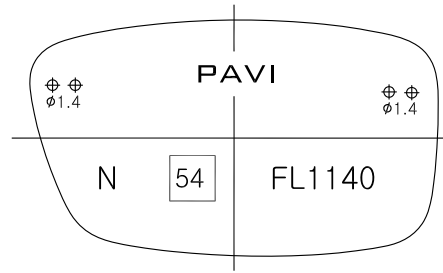
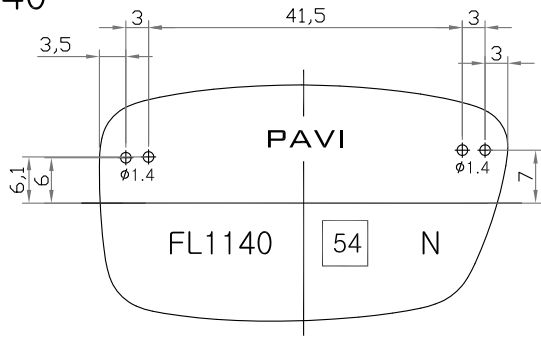

# FL1145

56 □ 18

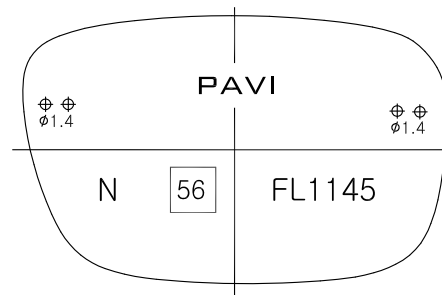
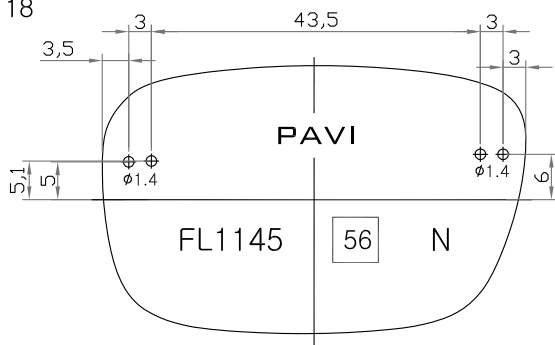

# FL1150

54 □ 18

